



Electrical enclosures for industrial applications



The technical Solution
www.etngroup.com



Contents

Terminal boxes 4

Industrial terminal boxes - ABS, polycarbonate, polyester.....	4
Mild steel / stainless steel & aluminium	6

Wall mounted enclosures 7

Polyester & polycarbonate	7
Mild steel "Multimount".....	8
Cable entry for mild steel enclosures	11
Stainless steel	12
Push-button boxes and accessories for stainless steel boxes	13

Floor standing enclosures 14

Monoblocks, painted sheet metal.....	14
Monoblocks with painted sheet metal and plinths.....	15
Painted sheet metal combinable enclosures.....	16
Stainless steel	18
Accessories for floor standing enclosures.....	20

Consoles 21

Floor standing consoles.....	21
Control panels & swing arms.....	22

PC enclosure range & 19" enclosures 24

PC enclosure range	
Free standing working station.....	24
Customized 19" enclosures electronic cabinets subracks - front panels.....	25

MULTICOM outdoor cabinets 27

EKOM range.....	27
ECOM range	28

Thermal management 29

Filter fans, heaters and thermostats.....	29
Enclosure lighting	30
Cooling units / Heat exchangers	31

General accessories 32

Profiles, cable management.....	32
Lights, sockets, visualisation windows, paint cans.....	33

Technical information 34

Materials selection.....	34
Ip rates	35



TEMPO range

Terminal box, IP65, IK07, RAL7035

1 kit of quick to install hinges and 4 self-tapping screws included in the delivery. Market compatible dimensions and mounting pods. Large plain cover offering lots of space for screen-printing, stickers, etc. Sealing system included in the lid.

Grey cover, with terminal and integrated grommets

Dimensions (W x H x D)	Description	Reference
95 x 65 x 60	with integrated grommet, terminals (1-4mm ²)	FIB5834002
95 x 65 x 60	with metric knock-outs, terminals (1-25mm ²)	FIB5834004
110 x 110 x 65	with integrated grommet, terminals (1-4mm ²)	FIB5834011
110 x 110 x 65	with metric knock-outs, terminals (1-25mm ²)	FIB5834013
130 x 130 x 75	with metric knock-outs, terminals (1-25mm ²)	FIB5834021



Empty boxes plain sides or with knock-outs

Dimensions (W x H x D)	ABS grey cover		PC transparent cover	Mounting plate
	Plain sides	With knock outs	Plain sides	
96 x 65 x 60	FIB5814038	FIB5814020		
110 x 110 x 65	FIB5814039	FIB5814021		
130 x 95 x 65	FIB5814040	FIB5814022		
130 x 130 x 75	FIB5814041	FIB5814023		
187 x 122 x 90	FIB5814000	FIB5814024	FIB5824005	FIB5518022
187 x 122 x 134	FIB5814050			
201 x 163 x 98	FIB5814001	FIB5814025	FIB5824006	FIB5518023
201 x 163 x 142	FIB5814051			
240 x 191 x 107	FIB5814002		FIB5824007	FIB5518024
240 x 191 x 151	FIB5814052			
289 x 239 x 107	FIB5814003		FIB5824008	FIB5518025
289 x 239 x 151	FIB5814053			
344 x 289 x 117	FIB5814004		FIB5824009	FIB5518026
344 x 289 x 161	FIB5814054			
Mounting brackets (set of 2)		FIB5510674		



MNX

Terminal boxes, IP67, IL08 - RAL7035 - T° range: -40 / + 120 ° C.

Glow wire test: 960 ° C - Self-extinguishing: UL94-5V, V0 - Halogen free.

UV resistance: UL508, 720 h in climatic chamber.

Very good resistance to chemical agents, oil, hydrocarbon, alcohol, salt spray...

Dimensions			Reference - Polycarbonate		
H	W	D	Grey cover	Transparent cover	Mounting plate
100	100	35	FIB6012331	FIB6012931	
		50	FIB6012332	FIB6012932	
		60	FIB6011331		
		75	FIB6011332		
130	80	35	FIB6012301	FIB6012901	FIB5514076
		50	FIB6012302	FIB6012902	FIB5514076
		60	FIB6011301	FIB6011901	FIB5514076
		75	FIB6011302	FIB6011902	FIB5514076
		100	FIB6011303		FIB5514076
		125	FIB6011304		FIB5514076
130	130	35	FIB6012307	FIB6012907	FIB5514077
		50	FIB6012308		FIB5514077
		60	FIB6011307	FIB6011907	FIB5514077
		75	FIB6011308	FIB6011908	FIB5514077
		100	FIB6011309	FIB6011909	FIB5514077
		125	FIB6011310	FIB6011910	FIB5514077

Dimensions			Reference - Polycarbonate			
H	W	D	Grey cover	Transparent cover	Mounting plate	
180	130	35	FIB6012313	FIB6012913	FIB5514078	
		50	FIB6012314	FIB6012914	FIB5514078	
		60	FIB6011313	FIB6011913	FIB5514078	
		75	FIB6011314	FIB6011914	FIB5514078	
		85	FIB6013333		FIB5514078	
		100	FIB6013334		FIB5514078	
	255	180	60	FIB6011319	FIB6011919	FIB5514079
			75	FIB6011320	FIB6011920	FIB5514079
			63	FIB6011324	FIB6011924	FIB5514080
			75	FIB6011326	FIB6011926	FIB5514080
360	255	88	FIB6013330	FIB6013930	FIB5514080	
		100	FIB6013326		FIB5514080	
		125	FIB6013327	FIB6013927	FIB5514080	
		175	FIB6013329	FIB6013929	FIB5514080	
		152	FIB6017338	FIB6017938	FIB5514585	

Also available in ABS (Ip67 - IK07), other dimensions.
Wide range of accessories - Please contact us.

PICCOLO

Terminal boxes. ABS: IP66 / 67 - IK07 ; PC: IP66 / 67 - IK08.
 Included in the delivery: Body + screws, cover with polyurethane gasket, polyamide cover screws.
 Terminal box with grey cover RAL7035.



Dimensions	Polycarbonate	ABS	Mounting plate
110 x 80 x 65	FIB8724303	FIB8784303	FIB8524060
110 x 80 x 85	FIB8724304	FIB8784304	FIB8524060
140 x 80 x 65	FIB8724305	-	FIB8524061
140 x 80 x 85	FIB8724306	FIB8784306	FIB8524061
170 x 80 x 65	FIB8724307	FIB8784307	FIB8524062
170 x 80 x 85	FIB8724308	FIB8784308	FIB8524062

Dimensions	Polycarbonate	ABS	Mounting plate
230 x 80 x 65	FIB8724311	FIB8784311	FIB8524063
230 x 80 x 85	FIB8724312	FIB8784312	FIB8524063
170 x 140 x 95	FIB8724315	FIB8784315	FIB8524064
230 x 140 x 95	FIB8724318	FIB8784318	FIB8524065
230 x 140 x 125	FIB8724319	FIB8784319	FIB8524065

Also available with a transparent cover - Please contact us.

EURONORD

Polycarbonate terminal boxes. IP66 / 67 - IK08 / 07.
 With grey cover RAL7035.
 160 standard models, optimised internal working area.
 Included in the delivery: Body with fixation screws, cover with polyurethane gasket and stainless steel screws.

Dimensions	Reference	Mounting plate
52 x 40 x 40	FIB7032500	FIB9512009
65 x 50 x 45	FIB7032520	FIB9512010
82 x 80 x 55	FIB7032540	FIB9512011
82 x 80 x 65	FIB7032560	FIB9512011
82 x 80 x 95	FIB7032570	FIB9512011
120 x 80 x 55	FIB7032580	FIB9512012
160 x 80 x 55	FIB7032630	FIB9512013
160 x 80 x 65	FIB7032620	FIB9512013
160 x 80 x 85	FIB7032650	FIB9512013
160 x 80 x 95	FIB7032640	FIB9512013
122 x 120 x 65	FIB7032660	FIB9512014
122 x 120 x 75	FIB7032670	FIB9512014
122 x 120 x 95	FIB7032680	FIB9512014

Dimensions	Reference	Mounting plate
160 x 120 x 90	FIB7032720	FIB9512036
160 x 120 x 140	FIB7032730	FIB9512036
200 x 120 x 75	FIB7032760	FIB9512015
244 x 124 x 102	FIB7032780	FIB9512016
201 x 151 x 80	FIB7032820	FIB9512017
244 x 164 x 90	FIB7032810	FIB9512022
250 x 160 x 90	FIB7032840	FIB9512018
250 x 160 x 125	FIB7032860	FIB9512018
300 x 230 x 87	FIB7032870	FIB9512019
300 x 230 x 110	FIB7032890	FIB9512019



Also available in ABS or polyester.
 ABS and polyester models also available with a transparent cover.

SOLID

Terminal boxes IP67, IK08, RAL7035.
 Ideal solution for housing all types of electronic or electrical devices, also an cost-effective alternative solution to the polyester enclosures.
 Also available in ABS or polycarbonate. Screwed cover or hinged cover.



Outside Dimensions (mm)	ABS	Polycarbonate		Mounting plate	Extension frame
	grey cover	grey cover	grey cover		
190 x 190 x 130	FIB5880359	FIB5330359	FIB5330059	FIB3770548	-
190 x 190 x 180	-	FIB5330369	FIB5330069	FIB3770548	-
280 x 190 x 130	FIB5880360	FIB5330360	FIB5330060	FIB3770549	FIB3730153
280 x 190 x 180	-	FIB5330370	FIB5330070	FIB3770549	FIB3730153
280 x 280 x 130	FIB5880362	FIB5330362	FIB5330062	FIB3770551	FIB3730093
280 x 280 x 180	FIB5880372	FIB5330372	FIB5330072	FIB3770551	FIB3730093
380 x 190 x 130	FIB5880361	FIB5330361	FIB5330061	FIB3770550	FIB3730152
380 x 190 x 180	-	FIB5330371	FIB5330071	FIB3770550	FIB3730152
380 x 280 x 130	FIB5880363	FIB5330363	FIB5330063	FIB3770552	FIB3730141
380 x 280 x 180	FIB5880373	FIB5330373	FIB5330073	FIB3770552	FIB3730141
560 x 280 x 130	-	FIB5330364	FIB5330064	FIB3770553	FIB3730142
560 x 380 x 180	-	FIB5330365	FIB5330065	FIB3770554	FIB3730323

STB: Mild steel, painted RAL7035

SSBT: Stainless steel 304L (316L also possible)

Screwed lid - IP66 - NEMA4X - IK08 - Mounting plate or DIN profiles available as accessory.

Dimensions (mm)			Terminal box		Mounting plate	Vertical perforated profiles (2pcs)	Set of 5 horizontal DIN profiles	
H	W	D	mild steel RAL7035	stainless steel 304L				
150	150	80	ELDSTB151508	ELDSSTB151508	ELDBMP1515	ELDBPP15	ELDBDR3515	
		120	ELDSTB151512	ELDSSTB151512	ELDBMP1515	ELDBPP15	ELDBDR3515	
	300	80	ELDSTB153008	ELDSSTB153008	ELDBMP1530	ELDBPP15	ELDBDR3530	
		120	ELDSTB153012	ELDSSTB153012	ELDBMP1530	ELDBPP15	ELDBDR3530	
200	200	80	ELDSTB202008	ELDSSTB202008	ELDBMP2020	ELDBPP20	ELDBDR3520	
		120	ELDSTB202012	ELDSSTB202012	ELDBMP2020	ELDBPP20	ELDBDR3520	
	300	80	ELDSTB203008	ELDSSTB203008	ELDBMP2030	ELDBPP20	ELDBDR3530	
		120	ELDSTB203012	ELDSSTB203012	ELDBMP2030	ELDBPP20	ELDBDR3530	
	400	400	80	ELDSTB204008	ELDSSTB204008	ELDBMP2040	ELDBPP20	ELDBDR3540
			120	ELDSTB204012	ELDSSTB204012	ELDBMP2040	ELDBPP20	ELDBDR3540
		500	120	ELDSTB205012	ELDSSTB205012	ELDBMP2050	ELDBPP20	ELDBDR3550
			600	ELDSTB206012	ELDSSTB206012	ELDBMP2060	ELDBPP20	ELDBDR3560
800	ELDSTB208012	ELDSSTB208012	ELDBMP2080	ELDBPP20	ELDBDR3580			
300	300	80	ELDSTB303008	ELDSSTB303008	ELDBMP3030	ELDBPP30	ELDBDR3530	
		120	ELDSTB303012	ELDSSTB303012	ELDBMP3030	ELDBPP30	ELDBDR3530	
	400	120	ELDSTB304012	ELDSSTB304012	ELDBMP3040	ELDBPP30	ELDBDR3540	
		500	ELDSTB305012	ELDSSTB305012	ELDBMP3050	ELDBPP30	ELDBDR3550	
600	120	ELDSTB306012	ELDSSTB306012	ELDBMP3060	ELDBPP30	ELDBDR3560		
	400	ELDSTB404012	ELDSSTB404012	ELDBMP4040	ELDBPP40	ELDBDR3540		
600	120	ELDSTB406012	ELDSSTB406012	ELDBMP4060	ELDBPP40	ELDBDR3560		
	800	ELDSTB408012	ELDSSTB408012	ELDBMP4080	ELDBPP40	ELDBDR3580		



STB



SSBT

Accessories

Hinges (set of 2):

Zn plated: ELDSTBH02

316L stainless steel: ELDSSTBH02

Wall mounting brackets (set of 4):

Zn plated: ELDAW41

304 stainless steel: ELDAWS41-304

316L stainless steel: ELDAWS41-316

CA - Aluminium terminal boxes

Aluminium pressure die casting moulded boxes, paint RAL7001.

Screwed cover - IP66/67 - PUR gasket - IK09.

Wall mounting brackets, mounting plates, profiles to order separately.



Dimensions (mm)			Terminal box	Mounting plate
H	W	D		
50	45	30	BER1020000000	----
58	64	36	BER1060000000	BER9511001000
98	64	36	BER1080000000	BER9511002000
150	64	36	BER1100000000	BER9511003000
75	80	57	BER1130000000	BER9823015000
125	80	57	BER1150000000	BER9823016000
125	80	57	BER1160000000	BER9823016000
175	80	57	BER1170000000	BER9823017000
250	80	57	BER1190000000	BER9823021000
122	122	80	BER1210000000	BER9511150000
220	122	80	BER1230000000	BER9511095000
360	122	80	BER1250000000	BER9511174000
160	160	90	BER1270000000	BER9511149000
260	160	90	BER1290000000	BER9511096000
360	160	90	BER1310000000	BER9511175000
560	160	90	BER1330000000	BER9511014000
200	230	110	BER1350000000	BER9511015000
280	230	110	BER1370000000	BER9511016000
330	230	180	BER1390000000	BER9511017000
600	230	110	BER1420000000	BER9511019000



Other dimensions -> 600 x 310 x 180 available on request - Please contact us.
Machining possible on request - Please contact us.

BRES - Polyester wall mounted enclosure

Fiberglass reinforced polyester - IP66 - IK10 - RAL7035
 Self extinguishing - Glowing wire 960°C, double insulation
 Temperature range: -30 to + 60 ° C

Size H x W x D	Enclosure		Mounted plate			Inner door (polyester)
	Plain door	Perforated door	Galvanized	Insulating	Perforated	
300 x 250 x 140	SFBBRES325	SFBBRES325P	SFBPBM325	SFBPBP325	SFB9801348E	
400 x 300 x 200	SFBBRES43	SFBBRES43P	SFBPBM43	SFBPBP43	SFB9801338E	SFBPUI43
400 x 400 x 200	SFBBRES44	SFBBRES44P	SFBPBM44	SFBPBP44	SFB9801349E	SFBPUI44
500 x 400 x 200	SFBBRES54	SFBBRES54P	SFBPBM54	SFBPBP54	SFB9801345E	SFBPUI54
600 x 400 x 230	SFBBRES64	SFBBRES64P	SFBPBM64	SFBPBP64	SFB9801346E	SFBPUI64
600 x 500 x 230	SFBBRES65	SFBBRES65P	SFBPBM65	SFBPBP65	SFB9801351E	SFBPUI65
800 x 300 x 230	SFBBRES83	SFBBRES83P	SFBPBM83	SFBPBP83	-	SFBPUI83
800 x 600 x 300	SFBBRES86	SFBBRES86P	SFBPBM86	SFBPBP86	SFB9801347E	SFBPUI86

Accessories

Description	Reference
Wall mounting brackets (4 parts)	SFBO-OFM-14
DIN 3 mm lock (plastic)	SFBCDB10
Padlocking system (zn)	SFBCBC13
Padlocking system (s/steel)	SFBCBC13IN
Small ventilation device diam 19mm IP33	SFBDV-M
Large ventilation device diam 29mm IP44	SFBDV-G

Key locks: On request - Please contact us.



ARCA

Wall mounted enclosure polycarbonate, fiber glass reinforced polycarbonate, UV resistant.
 IP66 - IK10 - RAL7035
 Glow-wire (IEC 695-2-1): 960° C



Size H x W x D	Enclosure		Mounting plate		Modular chassis	Inner door (metal)	Pole Mounting kit
	Plain door	Galvanized	Perforated	Multi perforated			
300 x 200 x 150	FIB8120002N	FIB8120731	FIB8120751	FIB8120920	FIB8120760	FIB8120711	FIB8120840
400 x 300 x 150	FIB8120006N	FIB8120733	FIB8120753	FIB8120922	FIB8120764	FIB8120713	FIB8120841
400 x 300 x 210	FIB8120007N	FIB8120733	FIB8120753	FIB8120922	FIB8120765	FIB8120713	FIB8120841
500 x 400 x 210	FIB8120011N	FIB8120735	FIB8120755	FIB8120924	FIB8120769	FIB8120715	FIB8120842
600 x 400 x 210	FIB8120012N	FIB8120736	FIB8120756	FIB8120925	FIB8120770	FIB8120716	FIB8120842
700 x 500 x 300	FIB8120017N	FIB8120738	FIB8120758	FIB8120927	FIB8120775	FIB8120718	FIB8120843
800 x 600 x 300	FIB8120019N	FIB8120739	FIB8120759	FIB8120928	FIB8120777	FIB8120719	FIB8120844

Also available with a transparent door, or in other dimensions. Please contact us.

Accessories

Description	Reference	enclosure < 700 x 500	enclosure ≥ 700x500
Wall mounting brackets - 10mm spacer	FIB8120830		
Wall mounting brackets - 40 mm spacer	FIB8120831		
Corner supports - adjustable	D = 150 mm	FIB8120810	
Corner supports - adjustable	D = 210 mm	FIB8120811	
Corner supports - adjustable	D = 300 mm	FIB8120812	
Spare replacement lock DIN3mm		FIB8120860	FIB8120980
Key lock N°1242e		FIB8120865	FIB8120985
Key lock N°0455e		FIB8120867	FIB8120987

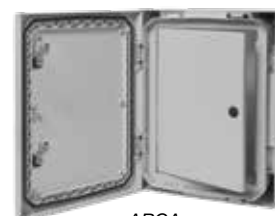

ARCA

MAS / MAD / MAP



Modular chassis AC



Inner door ADI



Door stop ELDADO202

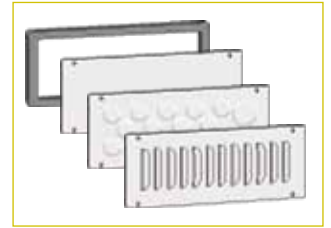

Ventilation plates, gland plates with knock-outs ...



Thermostats

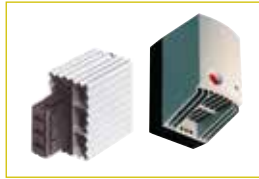

Heaters



Enclosures lights, door switches
Door contact ADSW01



Ventilation



MAD

IP55
Wall mounted enclosure, double doors



MAS

IP66
Wall mounted enclosure, single door



MAP

IP66
Wall mounted enclosure, "panel" shape



Lifting eyes
ELDAL9301



Pole mounting kit

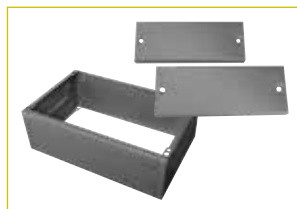

Plinths
H = 100 or 200 mm

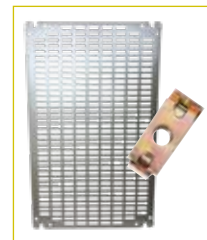

Perforated mounting
plate AMT
Clip nuts AF1EAx



Multi-perforated
mounting-plate AMX

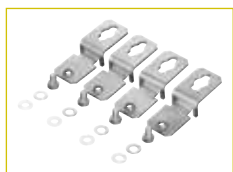

Wall mounting brackets
AW41



Document holder
DRA04



Pedestal
H = 300 or 450 mm
PFF



Galvanized mounting
plate AMP

WALL MOUNTED ENCLOSURES

Mild steel "Multimount"

MAS

Wall mounted enclosure, single door, mild steel, painted RAL7035, IP66, IK10.

Plain galvanized mounting plated included in the delivery.

Perforated or multi-perforated mounting plate to order separately.

Gland plate(s) and gasket(s) included in the delivery.

DIN3 mm lock fitted as standard.



Dimensions (mm)			Enclosure reference	Mounting plate		Gland plates		Number lock(s)	
H	W	D		Perforated	Multi-perforated	Number	Size		
200	200	155	ELDMAS0202015R5	-	-	1	0S	1	
250	200	155	ELDMAS0252015R5	-	-	1	0S	1	
	250	155	ELDMAS0252515R5	-	ELDAMX02525	1	0S	1	
300	250	155	ELDMAS0302515R5	ELDAMT03025	ELDAMX03025	1	0S	1	
		210	ELDMAS0302521R5			1	0S	1	
	300	155	ELDMAS0303015R5	ELDAMT03030	ELDAMX03030	1	1S	1	
		210	ELDMAS0303021R5			1	1	1	
350	250	155	ELDMAS0352515R5	-	-	1	0S	1	
400	300	155	ELDMAS0403015R5	ELDAMT04030	ELDAMX04030	1	1S	1	
		210	ELDMAS0403021R5			1	1	1	
	400	210	ELDMAS0404021R5	ELDAMT04040	ELDAMX04040	1	2	1	
	500	210	ELDMAS0405021R5	ELDAMT04050	ELDAMX04050	1	3	1	
	600	210	ELDMAS0406021R5	ELDAMT04060	ELDAMX04060	1	4	1	
500	300	210	ELDMAS0503021R5	ELDAMT05030	ELDAMX05030	1	1	1	
		400	155	ELDMAS0504015R5	ELDAMT05040	ELDAMX05040	1	2S	1
			210	ELDMAS0504021R5			1	2	1
			260	ELDMAS0504026R5			1	2	1
	500	300	210	ELDMAS0505021R5	ELDAMT05050	ELDAMX05050	1	3	1
			300	ELDMAS0505030R5			1	3	1
		400	155	ELDMAS0604015R5	ELDAMT06040	ELDAMX06040	1	2S	2
400	210	ELDMAS0604021R5	1	2			2		
	260	ELDMAS0604026R5	1	2			2		
	300	ELDMAS0604030R5	1	2			2		
600	500	155	ELDMAS0605015R5	ELDAMT06050	ELDAMX06050	1	3S	2	
		210	ELDMAS0605021R5			1	3	2	
		260	ELDMAS0605026R5			1	3	2	
		300	ELDMAS0605030R5			1	3	2	
	600	210	300	ELDMAS0606021R5	ELDAMT06060	ELDAMX06060	1	4	2
			300	ELDMAS0606030R5			1	4	2
		400	300	ELDMAS0606040R5	1	4	2		
			800	300	ELDMAS0608030R5	ELDAMT06080	ELDAMX06080	2	2
700	500	210	ELDMAS0705021R5	ELDAMT07050	ELDAMX07050	1	3	2	
		260	ELDMAS0705026R5			1	3	2	
800	400	300	ELDMAS0804030R5	-	-	1	2	2	
		600	210	ELDMAS0806021R5	ELDAMT08060	ELDAMX08060	1	4	2
			260	ELDMAS0806026R5			1	4	2
			300	ELDMAS0806030R5			1	4	2
			400	ELDMAS0806040R5			1	4	2
	800	210	300	ELDMAS0808021R5	ELDAMT08080	ELDAMX08080	2	2	2
			300	ELDMAS0808030R5			2	2	2
		400	300	ELDMAS0808040R5	2	2	2		
			600	260	ELDMAS1006026R5	ELDAMT10060	ELDAMX10060	1	4
300	ELDMAS1006030R5	1	4	1*					
1000	800	260	ELDMAS1008026R5	ELDAMT10080	ELDAMX10080	2	2	1*	
		300	ELDMAS1008030R5			2	2	1*	
	600	300	ELDMAS1206030R5	ELDAMT12060	-	1	4	1*	
		800	300	ELDMAS1208030R5	ELDAMT12080	ELDAMX12080	2	2	1*
400	ELDMAS1208040R5		2	2			1*		

*: 3 points espagnolette locking

Mild steel "Multimount"

MAD

Wall mounted enclosure, double doors, mild steel, painted RAL7035 - IP55 - IK10.

Plain galvanized mounting plated included in the delivery.

Perforated or multi-perforated mounting plate to order separately.

Gland plate(s) and gasket(s) included in the delivery.

DIN3 mm lock fitted as standard.



Dimensions (mm)			Enclosure reference	Mounting plate		Gland plates	
H	W	D		Perforated	Multi-perforated	Number	Size
600	800	300	ELDMAD0608030R5	ELDAMT06080	ELDAMX06080	2	2
800	1200	300	ELDMAD0801230R5	ELDAMT08120	ELDAMX08120	2	4
1000	1000	300	ELDMAD1001030R5	ELDAMT10100	ELDAMX10100	2	3
1200	1000	300	ELDMAD1201030R5	ELDAMT12100	ELDAMX12100 *	2	3
1200	1200	300	ELDMAD1201230R5	ELDAMT12120 *	ELDAMX12120 *	2	4
1200	1200	400	ELDMAD1201240R5	ELDAMT12120 *	ELDAMX12120 *	2	4
1400	1000	300	ELDMAD1401030R5	-	-	2	3

*: Those models are not always available from the shelf - Please contact us.

MAP

Mild steel wall mounted enclosure "panel" shape, painted RAL7035, single door, IP66, IK10.

Plain galvanized mounting plated included in the delivery.

Gland plate openings in the top + bottom. Gland plate(s) and gasket(s) have to be ordered separately.

DIN3 mm lock fitted as standard. This enclosure can be instead on the top or at the bottom of a MAS or MAD enclosure with same width and depth.



Dimensions (mm)			Enclosure reference	Gland plates		Gasket
H	W	D		Number	Enclosure	Enclosure
300	600	300	ELDMAP0306030R5	2	ELDAF04R5	EDLAG04
300	800	300	ELDMAP0308030R5	4	ELDAF02R5	ELDAG02
300	1000	300	ELDMAP0310030R5	4	ELDAF03R5	ELDAG03
300	1200	300	ELDMAP0312030R5	4	ELDAF04R5	ELDAG04



Plinths for MULTIMOUNT enclosures

Painted RAL7022

For enclosure	Plinth H100		Plinth H200	
	W	D	W	D
400	260	ELDP1040 + ELDPA1026	ELDP2040 + ELDPA2026	
	300	ELDP1040 + ELDPA1030	ELDP2040 + ELDPA2030	
500	260	ELDP1050 + ELDPA1026	ELDP2050 + ELDPA2026	
	300	ELDP1050 + ELDPA1030	ELDP2050 + ELDPA2030	
600	260	ELDP1060 + ELDPA1026	ELDP2060 + ELDPA2026	
	300	ELDP1060 + ELDPA1030	ELDP2060 + ELDPA2030	
	400	ELDP1060 + ELDPA1040	ELDP2060 + ELDPA2040	

For enclosure	Plinth H100		Plinth H200	
	W	D	W	D
800	260	ELDP1080 + ELDPA1026	ELDP2080 + ELDPA2026	
	300	ELDP1080 + ELDPA1030	ELDP2080 + ELDPA2030	
1000	400	ELDP1080 + ELDPA1040	ELDP2080 + ELDPA2040	
	300	ELDP1100 + ELDPA1030	ELDP2100 + ELDPA2030	
1200	300	ELDP1120 + ELDPA1030	ELDP2120 + ELDPA2030	
	400	ELDP1120 + ELDPA1040	ELDP2120 + ELDPA2040	

Various accessories

Description	Reference
Replacement DIN 3mm lock	ELDALL503N
Key handle	Key number 0455e
Key handle	Key number 1242nd
Wall mounting brackets (set of 4)	ELDAW41
Lifting eyes (pair)	ELDAL9301
Adhesive A4 plan pocket	ELDDRA04
Door contact + mounting bracket	ELDADSW01
Neon strip 12 W - 230 V AC	FANCLGT2312
Fix magnet for CGLT	FANCLG-TSM1
LED strip 4 W - 230 V AC	ELDTL4001-4W

Pedestals for MULTIMOUNT cabinets

Mild steel - Painted RAL7035

Height	For enclosures D =	Reference
300	300	ELDPFF330R5
300	400	ELDPFF430R5
450	300	ELDPFF345R5
450	400	ELDPFF445R5

Different types of locks available on request. Please contact us.



PFF

Gland plates with knock-outs

Mild steel - Painted RAL7035

Size	Reference	Description
1	ELDAFK11R5	4M16 + 5M20 + 2M25 + 2M32
2	ELDAFK21R5	9M16 + 5M20 + 4M25 + 2M32
3	ELDAFK31R5	18M16 + 5M20 + 4M25 + 2M32
4	ELDAFK41R5	27M16 + 5M20 + 4M25 + 2M32
4	ELDAFK42R5	18M16 + 14M20 + 3M25 + 1M32



AFK

EPDM cable glands

IP66 - RAL7035

Size	Reference	Capacity
M16	TST1458304	5 to 9 mm
M20	TST1458305	8 to 13 mm
M25	TST1458306	11 to 17 mm
M32	TST1458307	15 to 20 mm
M40	TST1458308	19 to 28 mm
M50	TST1458309	27 to 35 mm



Two components grommet, with strain relief

RAL7035 - Fit on walls from 2 to 5mm thickness

Size	Reference	Capacity
M20	TST1475803	7 to 11 mm
M25	TST1475804	7 to 13 mm



Gland plates with cut-out to combine with a plastic flange FL13 or FL21 format (to be ordered separately)

Metallic gland plate with opening - RAL7035		
Size	Reference	Description
1	ELDAFA01R5	1 opening FL13
2	ELDAFA02R5	1 opening FL21
3	ELDAFA03R5	1 opening FL21
4	ELDAFA04R5	2 openings FL21



AFA

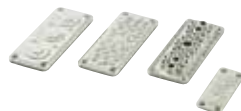

FIB

Plastic flange - IP65 - RAL7035		
Size	Reference	Description
FL13	FIB3590794	8 openings for Ø 2.5 to 25 mm + 1 RJ45
FL21	FIB3590795	7 openings for Ø 3 to 55 mm
FL21	FIB3590796	29 openings for Ø 3 to 26 mm + 1 RJ45
FL21	FIB3590797	43 openings for Ø 3 to 30 mm + 1 RJ45

"Design-A-Flange" - Plastic flange, modular, to create

Based on a FL21 format frame, you add the desired flange inserts.

This plate is re-combinable. The frame fits in the FL21 openings of the AFA gland plates.

Frame		Reference
Frame FL21 format	Capacity 5 modules	TST2665400

Inserts		
Description	Modules numbers	Reference
9 x Ø 7 mm	2	TST2665408
2 x Ø 20 to 30 + 2 x Ø 10 to 20	2	TST2665409
2 x Ø 8 to 17	1	TST2665411
10 x Ø 4 to 10	1	TST2665413

Different other inserts are available from this range - Please contact us.
A software is at your disposal to define your tailored solution.



Cable entry plates

Several entries in one plate - IP54 - To fit on wall 1.5 to 2.5mm thick

Cut-out Size	Reference	Description
M30	ICO43532	6xD5.2 + 2xD6.4 + 2xD9.4
M50	ICO43550	4xD5.3 + 5xD6.3 + 3xD9.5 + 4xD11.3
M50	ICO43551	10xD9.2 + 2xD11.2
M50	ICO43552	16xD6.3 + 4xD9.3
M50	ICO43553	5xD11.7 + 5xD6.3 + 4xD6.5 + 2xD5.5 + 2xD4
M50	ICO43554	5xD7 + 4xD18



Standard stainless steel wall mounted enclosures

ASR: Single door - IP66 / NEMA 4X ADR: Double door - IP55 / NEMA 12-13

Galvanized mounting plate included in the delivery.

304L stainless steel (316L s/steel possible on request).

Finish: 400 pre-grained stainless steel.

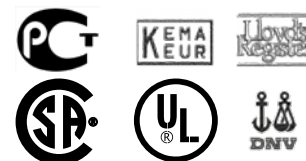

Dimensions (mm)				Reference	Number of lock(s)	Dimensions (mm)				Reference	Number of lock(s)
H	W	D	H			W	D				
180	240	150	ELDASR0182415	1	600	600	210	ELDASR0606021	2		
240	240	150	ELDASR0242415	1	600	600	300	ELDASR0606030	2		
240	360	150	ELDASR0243615	1	600	800	300	ELDASR0608030	2		
300	200	150	ELDASR0302015	1	800	600	210	ELDASR0806021	2		
360	240	150	ELDASR0362415	1	800	600	300	ELDASR0806030	2		
400	300	150	ELDASR0403015	1	800	800	300	ELDASR0808030	2		
400	300	210	ELDASR0403021	1	1000	800	300	ELDASR1008030	1 (*)		
400	400	210	ELDASR0404021	1	1000	1000	300	ELDADR1001030	1 (*)		
400	600	210	ELDASR0406021	1	1000	1200	300	ELDADR1001230	1 (*)		
500	400	210	ELDASR0504021	1	1200	800	300	ELDASR1208030	1 (*)		
500	500	210	ELDASR0505021	1	1200	800	400	ELDASR1208040	1 (*)		
600	400	210	ELDASR0604021	2	1400	800	400	ELDASR1408040	1 (*)		



ASR

1 (*) Espagnolette 3 points locking system

Wall mounting brackets (4pcs): - 304 s/steel: ELDAWS41-304 - 316 s/steel: ELDAWS41-316

Stainless steel wall mounted enclosures with integrated sloping roof

AFS: Single door - IP66/NEMA4x

Galvanized mounting plate included in the delivery.

304L stainless steel (316L possible on request). Finish: 400 pre-grained stainless steel.



Dimensions (mm)				Reference	Number of lock(s)	Dimensions (mm)				Reference	Number of lock(s)
H	W	D	H			W	D				
300	200	150	ELDAFS03021	1	600	800	300	ELDAFS06083	2		
400	300	150	ELDAFS04031	1	800	600	210	ELDAFS08062	2		
400	400	210	ELDAFS04042	1	800	600	300	ELDAFS08063	2		
400	600	210	ELDAFS04062	1	800	800	300	ELDAFS08083	2		
500	500	210	ELDAFS05052	1	1000	800	300	ELDAFS10083	3		
600	400	210	ELDAFS06042	2	1200	600	300	ELDAFS12063	3		
600	600	210	ELDAFS06062	2	1200	800	300	ELDAFS12083	3		
600	600	300	ELDAFS06063	2	1400	800	400	ELDAFS14084	3		



AFS

Spare hygienic design lock: ELDALLS-HYG

Corresponding HD key: ELDLSK-HYG

Stainless steel wall mounted enclosures - Hygienic design

Designed to meet the F&B industry requirements

HDW: Single door - IP66/69K - NEMA4x

Galvanized mounting plate included in the delivery.

Stainless steel 304L (316L possible on request).

Finish: 400 pre-grained s/steel, polished to Ra<0.8µ

Special "hygienic" lock DIN EN 1672-2-2009, reversible door.

Blue silicon removable gasket - acc. FDA 21 CFR 177.2600.

Integrated sloping roof with an angle of 30° + 30mm overhang.



HDW

Dimensions (mm)				Reference	Number of lock(s)	Dimensions (mm)				Reference	Number of lock(s)
H	W	D	H			W	D				
442/350	220	155	ELDHDW0442215	2	772/650	390	210	ELDHDW0773921	2		
552/430	390	210	ELDHDW0553921	2	772/650	610	210	ELDHDW0776121	2		
552/430	810	210	ELDHDW0558121	2	825/650	810	300	ELDHDW0828130	2		
605/430	610	300	ELDHDW0606130	2	1225/1050	810	300	ELDHDW1228130	3		
672/550	510	210	ELDHDW0675121	2	1425/1250	810	300	ELDHDW1428130	3		

Wall mounting spacers (1 piece) 304 s/steel: H = 50 mm: ELDAWHD050 H = 300 mm: ELDAWHD300

Levelling feet M12 (4 pieces) 304 s/steel: ELDLFHD04

Push-button boxes "hygienic design"

IP69K - 304 s/steel (316 possible on request)

Dimensions	Blind cover	Cover with holes	Number of holes
82 x 82 x 89	LIMDEH01/304	LIMPEH01/304	1
140 x 82 x 89	LIMDEH02/304	LIMPEH02/304	2
202 x 82 x 89	LIMDEH03/304	LIMPEH03/304	3



"Hygienic design": extra-flat

The cable gland from our PROGRES Ultra-Flat range are a true innovation design and guarantee an efficient cleaning due to their ultra-flat shape.

EHEDG compliant (European Hygienic Engineering & Design Group)

IP68/69K - Front ring 304L stainless steel - A class strain relief

Description	Reference
M16 x 1.5 Ø 5 to 6.5 mm cable	AGR1040179630065
M16 x 1.5 Ø 6.5 to 8 mm cable	AGR1040179630080
M20 x 1.5 cable Ø 8 to 10.5 mm	AGR1040209630105
M25 x 1.5 Ø 8 to 11 mm cable	AGR1040259630110
M25 x 1.5 Ø 11 to 15 mm cable	AGR1040259630150

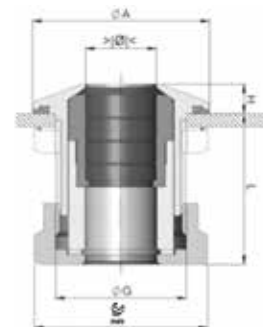

Pressure compensation device

Plastic

Description	Reference
M12 x 1.5 Polyamide, black, IP66 / 68 / 69K	AGR244512
M40 x 1.5 Plastic RAL7035, Ip66/69K (2 pieces)	STE28400000



Nickel plate brass

	Filter type			Counter screw for draining plug
	membrane IP66 / 68 / x9K	sintered bronze IP54 / x9K	stainless steel 304L IP4x	
M12 x 1.5	AGR24501234	AGR24501232	AGR24501236	AGR832412
M16 x 1.5	AGR24501734	AGR24501732	AGR24501736	AGR832417
M20 x 1.5	AGR24502034	AGR24502032	AGR24502036	AGR832420
PG7	AGR24500734	AGR24500732	-	-
PG11	AGR24501134	AGR24501132	-	-



Stainless steel

IP66 / 69K

Description	Reference
M40 x 1.5 304 stainless steel	STE28401000
M40 x 1.5 316L stainless steel	STE28401002



Drain plugs

Description	Reference
M50 x 1.5 Plastic, dark grey, IP66/67/69K	STE08410000



Filter fan covers

Dim. filter fan	304 stainless steel IP56	316L stainless steel	304 stainless steel + silicone blue gasket
105 x 105	FANSSC08	ELDEFCS20-316	FANSSC08A
150 x 150	FANSSC12	ELDEFCS20-316	FANSSC12A
204 x 204	FANSSC13	-	FANSSC13A
250 x 250	FANSSC15	ELDEFCS25-30-316	FANSSC15A
325 x 325	FANSSC20	ELDEFCS50-60-316	FANSSC20A



FLOOR STANDING ENCLOSURES

Compact, mild steel

MKS / MKD

MKS: Single door

MKD: Double door



Light + socket



Document pocket
Plastic - DRA04

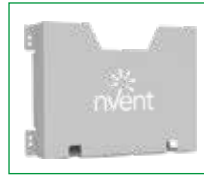

Document pocket
Metal - DRB



Drawing desk DDK



Lifting eyes
LE9304



Door switch - DSW01



Thermostats



Mounting plate MP



MKS / MKD



Ventilation



Door stop DSTP02

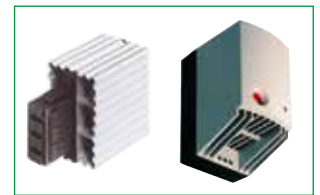

Heaters



Vertical profiles HP



LF 430



LCR

Casters and levelling feet

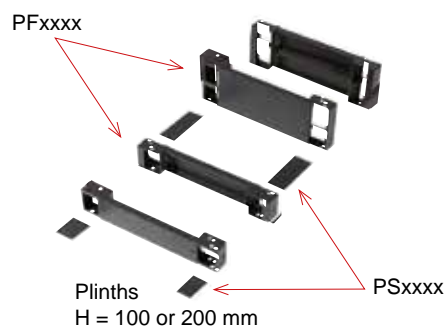

Cooling units

MKS / MKD - Compact floor standing enclosure, mild steel, painted RAL7035

MKS: Single door - IP55 - IK10 MKD: Double door - IP55 - IK10

Body th 1.5mm, door 2mm, mounting plate 3mm. Roof and rear panels removable.

Galvanized mounting plate and sliding bottom plate (2 or 3 parts) for cable entry included in the delivery. (D=300: 2 parts - D=400 and above: 3 parts)

For an enclosure without mounting plate, please add 'PE" before the "R5" in the reference.

Dimensions (mm)					Enclosure	Dimensions (mm)					Enclosure
H	W	D	Number of doors	Enclosure		H	W	D	Number of doors		
1200	600	400	1	ELDMKS12064R5	1800	600	400	1	ELDMKS18064R5		
1200	800	400	1	ELDMKS12084R5	1800	800	400	1	ELDMKS18084R5		
1200	1200	400	2	ELDMKD12124R5	1800	800	500	1	ELDMKS18085R5		
1400	600	300	1	ELDMKS14063R5	1800	1000	400	1	ELDMKS18104R5		
1400	600	400	1	ELDMKS14064R5	1800	1200	400	2	ELDMKD18124R5		
1400	800	300	1	ELDMKS14083R5	1800	1200	500	2	ELDMKD18125R5		
1400	800	400	1	ELDMKS14084R5	1800	1600	400	2	ELDMKD18164R5		
1400	1000	300	2	ELDMKD14103R5	1800	1600	500	2	ELDMKD18165R5		
1400	1000	400	2	ELDMKD14104R5	2000	600	400	1	ELDMKS20064R5		
1400	1200	300	2	ELDMKD14123R5	2000	800	400	1	ELDMKS20084R5		
1400	1200	400	2	ELDMKD14124R5	2000	800	500	1	ELDMKS20085R5		
1600	600	300	1	ELDMKS16063R5	2000	1000	400	1	ELDMKS20104R5		
1600	600	400	1	ELDMKS16064R5	2000	1000	500	1	ELDMKS20105R5		
1600	800	300	1	ELDMKS16083R5	2000	1200	400	2	ELDMKD20124R5		
1600	800	400	1	ELDMKS16084R5	2000	1200	500	2	ELDMKD20125R5		
1600	800	500	1	ELDMKS16085R5	2000	1600	400	2	ELDMKD20164R5		
1600	1000	400	1	ELDMKS16104R5	2000	1600	500	2	ELDMKD20165R5		
1600	1000	500	1	ELDMKS16105R5							
1600	1200	400	2	ELDMKD16124R5							
1600	1200	500	2	ELDMKD16125R5							



To allow the mounting plates adjustment in depth: add the ELDMPD02 kit. Also available in stainless steel 304 or 316L: See EKSS / EKDS ranges on page 18-19.

Plinths for Multiflex floor standing enclosures - Paint RAL7022

Height 100 mm

Front/rear plinth + corners

For enclosure W=	Reference
400	ELDPF1040
500	ELDPF1050
600	ELDPF1060
800	ELDPF1080
1000	ELDPF1100
1200	ELDPF1120
1600	2XELDPF1080

Side plinths

For enclosures D=	MC and arm cells. MK
300	ELDPS1030
400	ELDPS1040
500	ELDPS1050
600	ELDPS1060
800	ELDPS1080

For the enclosures W=1600, add 1 ELDPCPxx at the junction of the 2 W=800 plinths.



Height 200

Front/rear plinth + corners

For enclosure W=	Reference
400	ELDPF2040
500	ELDPF2050
600	ELDPF2060
800	ELDPF2080
1000	ELDPF2100
1200	ELDPF2120
1600	2XELDPF2080

Side plinths

For enclosures D=	MC and arm cells. MK
300	ELDPS2030
400	ELDPS2040
500	ELDPS2050
600	ELDPS2060
800	ELDPS2080

For the enclosures W=1600, add 1 ELDPCPxx at the junction of the 2 W=800 plinths.

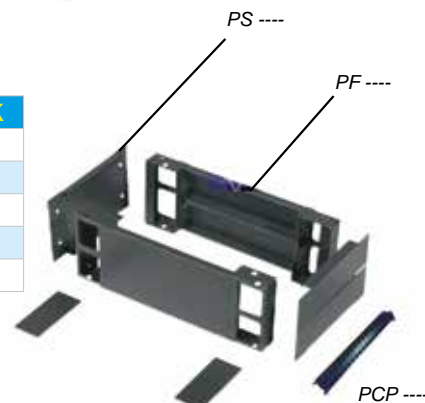

Plinths combining profiles

To use between bayed enclosures or bayed plinths.

	Reference
400	ELDPCP04
500	ELDPCP05
600	ELDPCP06
800	ELDPCP08

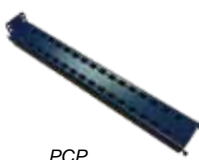

A complete plinth consists in 2 references:
 - Front / rear plinth + corners: ELDPFxxxx
 - Side plinth: ELDPSxxxx
 In case of combination: Use ELDPCPxx instead of 1 PSxxxx

MCS / MCD

MCS: single door

MCD : double door



Enclosure light + socket



Lifting eyes or lifting brackets
LE9304 - LC02



Door switch DSW01



Separation plate SPD



Door stop DSTP02



Mounting plate adjustment brackets MPD02



Drawing desk
DDK



SPM side panels

MPP partial stage

MP mounting plate



Vertical profiles HP



Metallic document holder DRB



MP mounting plate



Plastic document holder DRA04



Baying brackets

MCS



Plinths
H = 100 or 200 mm



Levelling feet and casters



Cooling units



Heaters



Ventilation



Thermostats

MCS / MCD

Combinable enclosures, mild steel, paint RAL7035 **MCS:** Single door - IP55 **MCD:** Double door - IP55

Mounting plate + rear back fixation brackets, sliding bottom plates (3 parts) included in the delivery.

If you need to adjust in depth the position of the mounting plate: Add the brackets kit ELDMPD02.

Body thickness 1.5 / 1.75 mm, roof and back panel 1.5 mm, door 2 mm, mounting plate 3 mm.

Dimensions (mm)			Number of door (s)	Enclosure	Side panels (the pair)	
H	W	D				
1800	500	500	1	ELDMCS18055R5	ELDSPM1805R5	
		400	1	ELDMCS18064R5	ELDSPM1804R5	
	600	500	1	ELDMCS18065R5	ELDSPM1805R5	
		600	1	ELDMCS18066R5	ELDSPM1806R5	
	800	400	1	ELDMCS18084R5	ELDSPM1804R5	
		500	1	ELDMCS18085R5	ELDSPM1805R5	
		500	2	ELDMCD18085R5	ELDSPM1805R5	
	1000	400	600	1	ELDMCS18086R5	ELDSPM1806R5
			400	1	ELDMCS18104R5	ELDSPM1804R5
		500	400	2	ELDMCD18104R5	ELDSPM1804R5
			500	1	ELDMCS18105R5	ELDSPM1805R5
	1200	500	2	ELDMCD18105R5	ELDSPM1805R5	
			2	ELDMCD18106R5	ELDSPM1806R5	
		400	2	ELDMCD18124R5	ELDSPM1804R5	
2000	500	500	2	ELDMCD18125R5	ELDSPM1805R5	
		600	2	ELDMCD18126R5	ELDSPM1806R5	
	600	400	2	ELDMCD18164R5	ELDSPM1804R5	
		400	1	ELDMCS20055R5	ELDSPM2005R5	
		400	1	ELDMCS20064R5	ELDSPM2004R5	
		500	1	ELDMCS20065R5	ELDSPM2005R5	
	800	600	1	ELDMCS20066R5	ELDSPM2006R5	
		800	1	ELDMCS20068R5	ELDSPM2008R5	
		400	1	ELDMCS20084R5	ELDSPM2004R5	
		500	1	ELDMCS20085R5	ELDSPM2005R5	
1000	500	2	ELDMCD20085R5	ELDSPM2005R5		
		2	ELDMCD20086R5	ELDSPM2006R5		
	600	600	1	ELDMCS20086R5	ELDSPM2006R5	
		800	1	ELDMCS20088R5	ELDSPM2008R5	
		400	1	ELDMCS20104R5	ELDSPM2004R5	
		400	2	ELDMCD20104R5	ELDSPM2004R5	
	1200	500	1	ELDMCS20105R5	ELDSPM2005R5	
		500	2	ELDMCD20105R5	ELDSPM2005R5	
600		1	ELDMCS20106R5	ELDSPM2006R5		
600		2	ELDMCD20106R5	ELDSPM2006R5		
1600	800	1	ELDMCS20108R5	ELDSPM2008R5		
		2	ELDMCD20108R5	ELDSPM2008R5		
	400	2	ELDMCD20124R5	ELDSPM2004R5		
		2	ELDMCD20125R5	ELDSPM2005R5		
	500	2	ELDMCD20126R5	ELDSPM2006R5		
		2	ELDMCD20128R5	ELDSPM2008R5		
2200	400	2	ELDMCD20164R5	ELDSPM2004R5		
		2	ELDMCD20165R5	ELDSPM2005R5		
	600	2	ELDMCD20166R5	ELDSPM2006R5		
		2	ELDMCD20166R5	ELDSPM2006R5		
2200	600	1	ELDMCS22066R5	ELDSPM2206R5		
		1	ELDMCS22068R5	ELDSPM2208R5		
	800	1	ELDMCS22086R5	ELDSPM2206R5		
		1	ELDMCS22088R5	ELDSPM2208R5		
	1000	2	ELDMCD22106R5	ELDSPM2206R5		
	1200	2	ELDMCD22126R5	ELDSPM2206R5		



MCS



MCD

Dimensions (mm)			Number of doors	Enclosure
H	W	D		
1800	400	400	1	ELDMCS18044R5
1800	400	500	1	ELDMCS18045R5
1800	400	600	1	ELDMCS18046R5
2000	400	400	1	ELDMCS20044R5
2000	400	500	1	ELDMCS20045R5
2000	400	600	1	ELDMCS20046R5
2000	400	800	1	ELDMCS20048R5

Cable enclosures

W = 400 - RAL7035

Without mounting plate, door frame, bottom plate (can be ordered separately)

Accessories:

Plinths and general accessories please see page 20 and 21.

Compact and combinable stainless steel enclosures

EKSS: Single door - IP66

MCSS: Single door - IP55

EKDS: Double door - IP55

MCDS: Double door - IP55



Enclosure light + socket



Document pocket
- plastic: DRA04

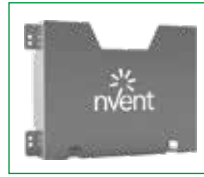

Document pocket
- metal: DRB
- 316L s/steel: DRBS



Drawing desk DDK



Lifting eyes s/steel
LE9316SS



Door switch - DSW01



LF 430



Levelling feet
and casters



Thermostats



Ventilation



Heaters



EKSS



Mounting plate MP



Door stop Zn or s/steel



Cooling units

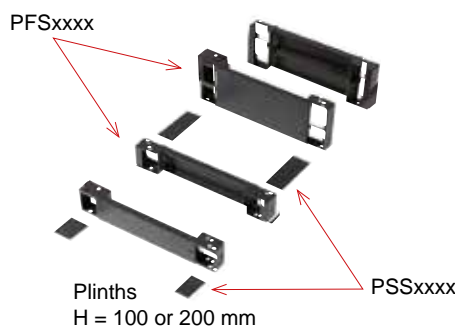

Vertical profiles HP

Monoblock cabinets

EKSS / EKDS

304 stainless steel (316L possible on request) - Finish: 400 pre-grained stainless steel - IK10

Monoblock roof, removable rear panel. Materials: Body, rear panel 1.5 mm stainless steel. Door 2mm stainless steel. Mp 3mm galvanized steel.

EKSS: Single door - IP66 - IK10

EKDS: Double door - IP55 - IK10

Mounting plate and 1 piece s/steel bottom plate included in the delivery. Bottom plate with extruded gasket. Add



Dimensions (mm)			Number of door(s)	Enclosure	Plinths		Rainhood
H	W	D			H100	H200	
1200	1200	400	2	ELDEKDS12124	ELDPFS1120 + ELDPSS1040	ELDPFS2120 + ELDPSS2040	ELDMSST1240
1400	800	400	1	ELDEKSS14084	ELDPFS1080 + ELDPSS1040	ELDPFS2080 + ELDPSS2040	ELDMSST0840
1600	600	400	1	ELDEKSS16064	ELDPFS1060 + ELDPSS1040	ELDPFS2060 + ELDPSS2040	ELDMSST0640
	800	400	1	ELDEKSS16084	ELDPFS1080 + ELDPSS1040	ELDPFS2080 + ELDPSS2040	ELDMSST0840
	1000	400	1	ELDEKSS16104	ELDPFS1100 + ELDPSS1040	ELDPFS2100 + ELDPSS2040	ELDMSST1040
	1200	400	2	ELDEKDS16124	ELDPFS1120 + ELDPSS1040	ELDPFS2120 + ELDPSS2040	ELDMSST1240
1800	600	400	1	ELDEKSS18064	ELDPFS1060 + ELDPSS1040	ELDPFS2060 + ELDPSS2040	ELDMSST0640
	800	400	1	ELDEKSS18084	ELDPFS1080 + ELDPSS1040	ELDPFS2080 + ELDPSS2040	ELDMSST0840
	1000	400	1	ELDEKSS18104	ELDPFS1100 + ELDPSS1040	ELDPFS2100 + ELDPSS2040	ELDMSST1040
	1200	400	2	ELDEKDS18124	ELDPFS1120 + ELDPSS1040	ELDPFS2120 + ELDPSS2040	ELDMSST1240
2000	1600	400	2	ELDEKDS18164	2xELDPFS1080 + 2xELDPSS1040	2xELDPFS2080 + 2xELDPSS2040	ELDMSST1640
	800	400	1	ELDEKSS20084	ELDPFS1080 + ELDPSS1040	ELDPFS2080 + ELDPSS2040	ELDMSST0840
	1000	400	1	ELDEKSS20104	ELDPFS1100 + ELDPSS1040	ELDPFS2100 + ELDPSS2040	ELDMSST1040
	1200	400	2	ELDEKDS20124	ELDPFS1120 + ELDPSS1040	ELDPFS2120 + ELDPSS2040	ELDMSST1240
2000	1600	400	2	ELDEKDS20164	2xELDPFS1080 + 2xELDPSS1040	2xELDPFS2080 + 2xELDPSS2040	ELDMSST1640

Combinable floor standing enclosures, stainless steel

304 stainless steel (316L possible on request) - Finish : 400 pre-grained stainless steel Materials: Body, roof, side & rear panels: 1.5 mm stainless steel. Door 2mm stainless steel. Mp 3mm galvanized steel

MCSS / MCDS

304 stainless steel (316L possible on request)

MCSS: Single door - IP55 **MCDS:** Double door - IP55

Mounting plate and 1 piece s/s bottom plate included in the delivery. Add the accessory ELDMPD02.



Dimensions (mm)			Number of door(s)	Enclosure	Side panels	Plinth		Galvanized
H	W	D				H100	H200	
1800	600	500	1	ELDMCSS18065	ELDSPMS1805	ELDPFS1060 + ELDPSS1050	ELDPFS2060 + ELDPSS2050	ELDDNGS1806
	800	500	1	ELDMCSS18085	ELDSPMS1805	ELDPFS1080 + ELDPSS1050	ELDPFS2080 + ELDPSS2050	ELDDNGS1808
	1000	500	1	ELDMCSS18105	ELDSPMS1805	ELDPFS1100 + ELDPSS1050	ELDPFS2100 + ELDPSS2050	ELDDNGS1810
		500	2	ELDMCDS18105	ELDSPMS1805	ELDPFS1100 + ELDPSS1050	ELDPFS2100 + ELDPSS2050	XXX
	1200	500	2	ELDMCDS18125	ELDSPMS1805	ELDPFS1120 + ELDPSS1050	ELDPFS2120 + ELDPSS2050	XXX
2000	600	600	1	ELDMCSS20066	ELDSPMS2006	ELDPFS1060 + ELDPSS1060	ELDPFS2060 + ELDPSS2060	ELDDNGS2006
	800	600	1	ELDMCSS20086	ELDSPMS2006	ELDPFS1080 + ELDPSS1060	ELDPFS2080 + ELDPSS2060	ELDDNGS2008
	1000	600	1	ELDMCSS20106	ELDSPMS2006	ELDPFS1100 + ELDPSS1060	ELDPFS2100 + ELDPSS2060	ELDDNGS2010
	1200	600	2	ELDMCDS20126	ELDSPMS2006	ELDPFS1120 + ELDPSS1060	ELDPFS2120 + ELDPSS2060	XXX

Accessories:

Lifting eyes 316L s/steel (4 pieces)	ELDLE9316SS
Spare replacement hinge set (for 1 enclosure):	
MCSS / EKSS	ELDDNMKS01
MCDS / EKDS	ELDDNMKS02

MCDS / EKDS	ELDDSTP02-316
Document holder 316L s/steel:	
W = 300	ELDDRBS03030-316L
W = 800	ELDDRBS0800-316L
W = 1000	ELDDRBS1000-316L

Accessories:

Accessories for floor standing enclosures

Description	Reference
Combination	
Internal baying brackets (6 pieces)	ELDCCI06
Internal corner baying kit (4 pieces)	ELDCCM04
External baying brackets (6 pieces)	ELDCCE06
Locks / Hinges	
T handle - key N°21323c	ELDLLH560N
Lift handle - key N°21323c	ELDLLH501N + ELDLHC522
Lift handle - other key N°	ELDLLH501N + ELDLHC522
Hinges set - single door enclosure (hinges + rod catches)	ELDDNMK01
Hinges set - double door enclosure (hinges + rod catches)	ELDDNMK02
Door hinges 180°	ELDDHN180
Document holders / Drawing desks	
Plastic - A4 - adhesive	ELDDRA04
Metal - L=300	ELDDRB0303R5
Metal - For door L=600 mm	ELDDRB600R5
Metal - For door L=800 mm	ELDDRB800R5
Drawing desk for door L=600 mm	ELDDDK600R5
Drawing desk for door L=800 mm	ELDDDK800R5
Miscellaneous	
Door stop	ELDDSTP02
Mounting plate complete fixation kit (6 pieces)	ELDMPA06
Mounting plate adjustment bracket (2 pieces)	ELDMPD02
Spacers (for roof plate) (4 pieces)	ELDCVK15
Lifting eyes (4 pieces)	ELDLE9304
Lifting brackets (2 pieces)	ELDLC02
Cable entry foam & bottom plates gasket	ELDBG01
Cable entry "click-in" profile + gasket	ELDSCExxx
Levelling feet (4 pieces)	ELDLF430
Casters (4 pieces)	ELDLCR470
Casters (4 pieces - 2 with brake)	ELDLCR471
Lights	
Fluo light + socket + magnet fix	STE02501005
Fluo light - no socket - screw mounting - 230 V AC	STE02527000
Fluo light - no socket - screw mounting - 230 V AC	FANCLGT2312
Magnetic mounting kit for CLGT light	FANCLG-TSM1
LED light - no socket - screw mounting - 230 V AC	FANFLL230565US
Magnetic mounting kit for FLL light	FANFLL2MA
LED light "eco" + switch - 4W 230V AC +1.75m cable	ELDTL4001-4W
Door switch	ELDDSW01



ELDCCE06



ELDCCM04



ELDDRB0303R5



ELDLE9304



ELDLF430



ELDLCRxxx



ELDCCI06



FANCLGT2312

Filler plate

For enclosure H=	Reference
1800	ELDMPF1800
2000	ELDMPF2000
2200	ELDMPF2200



Mounting profiles

For enclosure H=	Reference
1200	ELDCLPF1200
1400	ELDCLPF1400
1600	ELDHP1600
1800	ELDHP1800
2000	ELDHP2000
2200	ELDHP2200



ELDCLPFxxx

Many other accessories are available for this range:

- 19 "profiles
- Ventilation roofs
- Swing frames
- Partial doors & mounting plates

Don't hesitate to get in touch with us for more info.

Plinths for combinable enclosures MCS / MCD

Mild steel, paint RAL7022

One plinth is composed by 2 references:

PF: Front/rear part of the plinth

PS: Side panels of the plinth

When the plinths are used combined, it's possible to use a dedicated profile PCP instead of the side panel PS, to complete the plinth and at the same time allowing the cables to be routed between bayed enclosures.



Front + rear parts of the plinth

For enclosure W=	H = 100 mm	H = 200 mm
400	ELDPF1040	ELDPF2040
600	ELDPF1060	ELDPF2060
800	ELDPF1080	ELDPF2080
1000	ELDPF1100	ELDPF2100
1200	ELDPF1120	ELDPF2120

For W=1600 enclosures, you need to use 2xPF W=800 + 1 PS + 1 PCP.

Side panels for plinth (2 pieces)

For enclosure D = (in mm)	H = 100 mm	H = 200 mm
400	ELDPS1040	ELDPS2040
500	ELDPS1050	ELDPS2050
600	ELDPS1060	ELDPS2060
800	ELDPS1080	ELDPS2080

Plinth combining profiles (2 pieces)

For enclosure D = (in mm)	Reference
400	ELDPCP04
500	ELDPCP05
600	ELDPCP06
800	ELDPCP08

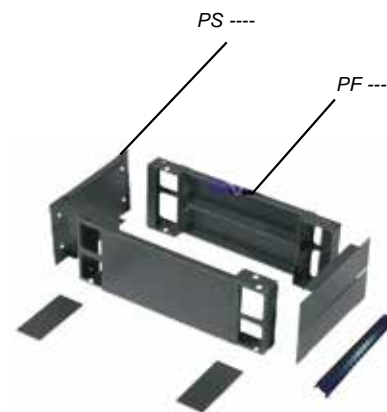

One-piece consoles - MPG

IP66/55 - IK10

Mild steel, paint RAL7035. Also available in stainless steel 304 or 316L on request.

Mounting plate + 2 parts bottom plate included in the delivery.

For W= 1200 and 1600: 2 front doors (IP55). Other dimensions: 1 door (IP66).

Top panel equipped with grip handle and panel stay.



Dimensions			Reference	Plinth H = 100	Plinth H = 200
H	W	D			
985	600	400	ELDMPG06R5	ELDPF1060 + ELDPST1040	ELDPF2060 + ELDPST2040
985	800	400	ELDMPG08R5	ELDPF1080 + ELDPST1040	ELDPF2080 + ELDPST2040
985	1000	400	ELDMPG10R5	ELDPF1100 + ELDPST1040	ELDPF2100 + ELDPST2040
985	1200	400	ELDMPG12R5	ELDPF1120 + ELDPST1040	ELDPF2120 + ELDPST2040
985	1600	400	ELDMPG16R5	2xELDPF1080 + ELDPST1040	2xELDPF2080 + ELDPST2040



Combinable console system MPC

IP66/55 - IK10

Combinable console system MPC Also available in stainless steel 304 or 316L on request.

For W= 1200 + 1600: 2 doors (IP55).

Other sizes: 1 door (IP66). Base equipped with mounting plate + 2 parts bottom plate + removable rear panel. Desk unit with grip handle and panel stay.



Width	Reference			Plinth H = 100	Plinth H = 200
	Base	Desk unit	Top unit		
600	ELDMPC063R5	ELDMPC062R5	ELDMPC061R5	ELDPF1060 + ELDPST1050	ELDPF2060 + ELDPST2050
800	ELDMPC083R5	ELDMPC082R5	ELDMPC081R5	ELDPF1080 + ELDPST1050	ELDPF2080 + ELDPST2050
1000	ELDMPC103R5	ELDMPC102R5	ELDMPC101R5	ELDPF1100 + ELDPST1050	ELDPF2100 + ELDPST2050
1200	ELDMPC123R5	ELDMPC122R5	ELDMPC121R5	ELDPF1120 + ELDPST1050	ELDPF2120 + ELDPST2050
1600	ELDMPC163R5	ELDMPC162R5	ELDMPC161R5	2xELDPF1080 + ELDPST1050	2xELDPF2080 + ELDPST2050

Control panels for HMI

OICE: Operator Interface Control Enclosures - IP55

Issued from the MAS series, dedicated to receive the HMI in industrial applications. Pre-machined hole to allow the fixation to a swing arm. Removable aluminium front plate. Rear door.



Dimensions	Reference
300 x 300 x 155	ELDOICE303015
300 x 400 x 210	ELDOICE304021
400 x 400 x 210	ELDOICE404021
400 x 600 x 210	ELDOICE406021
500 x 500 x 210	ELDOICE505021
500 x 600 x 210	ELDOICE506021
600 x 600 x 210	ELDOICE606021



CC3000 - Aluminium Control panel - IP65

Dedicated to house the HMI in industrial applications. 3 models available from the shelf, and infinite possibilities of customized versions possible on request. (specific size, customized front panel, machining ...).

Reference	Description	Dimensions (W x H x D)
BER1145300350	For 8 & 9" HMI	340x270x120mm
BER1145300270	For 10 & 12" HMI	420x360x120mm
BER1145300332	For 15" HMI	500x400x120mm



Operator Interface Control Panel Aluminium body & front panel

CC5000 Next

Aluminium control panel - customizable - IP65

This new range combines flexibility, functionality, ergonomics and good design. 2 models available from the shelf (RAL9006) as listed below, and customized version (dimensions, colours ...) possible on request.

Reference	Description	Dimensions (W x H x D)
BER1245500124	For 19" HMI	650 x 450 x 125
BER1845500104	For 21/22" HMI	742 x 541 x 185



CS3000 Next - Aluminium swing arms - light-duty suspension system

The new series CS3000Next is compatible with all the control panels listed on page 22.

Acceptable load: 800N with an extension arm length of 1m - RAL9006 - IP65.

Modern design, can easily be integrated in all the applications.

Adaptators are available to combine CS3000Next with elements from the CS2000 and CS3000 series.

Rep.	Reference	Description
1	BER1017300002	Straight coupling
2	BER1017300003	Elbow coupling
3	BER1017300007	Elbow
4	BER1017300010	Intermediate joint
5	BER1017300012	Wall joint W
6	BER1017300011	Wall joint S
7	BER1017300014	Top joint
8	BER1017300009	Reducing elbow
9	BER1017300004	Panel coupling S
	BER1017300005	Panel coupling W
11	BER9524700001	Tube L: 250 mm
	BER9524700002	Tube L: 500 mm
	BER9524700003	Tube L: 750 mm
	BER9524700004	Tube L: 1000 mm
	BER9524700006	Tube L: 1500 mm
	BER9808014900	Handle 200 mm
	BER9808015000	Handle 140 mm



CS3000 - Aluminium swing arm - heavy-duty suspension system

Compatible with all the control panel listed on page 22.

Acceptable load: 1250 N with an extension arm length of 1m - RAL7016 - IP65.

Multiple components combinations.

Rep.	Reference	Description
1	BER1015300001	Straight coupling
2	BER1015300002	Elbow coupling
3	BER1015300008	Elbow
4	BER1015300004	Intermediate joint
5	BER1015300007	Wall joint W
6	BER1015300006	Wall joint S
7	BER9524500001	Tube L = 250 mm
	BER9524500002	Tube L = 500 mm
	BER9524500003	Tube L = 750 mm
	BER9524500004	Tube L = 1000 mm
	BER9524500006	Tube L = 1500 mm
	BER9808014900	Handle - 200 mm
	BER9808015000	Handle - 140 mm

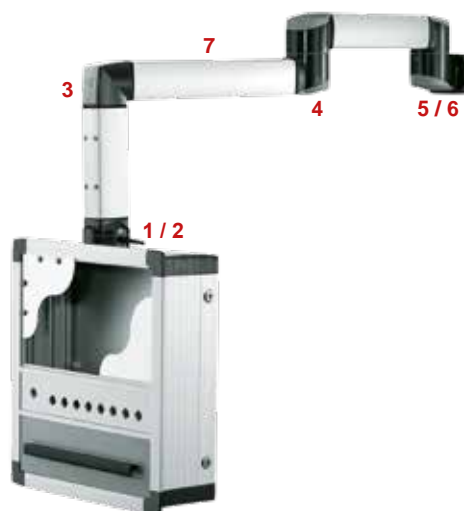

MCM - Industrial computer enclosure

RAL 7035 - IP44 - IK10

Pre-configured with integrated accessories to ease mounting of industrial computers & peripherals.

Full-height rear door, 2 front doors + 1 keyboard panel and sliding mouse pad.

1 monitor shelf included in the delivery.

Dimensions (HxWxD)	Reference	Plinth H100	Plinth H200
1600x600x600	ELDMCM16066	ELDPPF1060 + ELDPS1060	ELDPPF2060 + ELDPS2060
1600x600x800	ELDMCM16068	ELDPPF1060 + ELDPS1080	ELDPPF2060 + ELDPS2080



Free standing columns

CS4000Next free standing columns combines ergonomic visualisation and optimum integration of operating and input devices. Individual solutions for customer specific applications. Can hold IPC, screen, keyboard. The CS4000Next fulfils the requirements of the Machine Directive through the integration of emergency stops and actuators.

Product Features

High protection class IP65 at area of closed column chamber.

Internal cable routing.

IPC and keyboard shelf holder can be positioned individually.

IPC holds with graduated tilt control.

Optional integrated control elements (to fulfil the Machine Directive 2006/42/EG).

Column made of high-quality extruded aluminium sections (natural anodised - 2 chamber column).

Customer-specific length of the column possible.

Application fields

Production lines.

Plant and machine construction with decentralised controlling concept.

Decentralised display or HMI positioning.



CS-4000
next



Customized 19" enclosures ARISTAR, NOVASTAR - Electronics cabinets platform

CAD & 3D FILES AUTOMATIC CREATION

- Build-up your personalized 19" enclosure at a glance.

Test our NOVASTAR configurator !

- No sign in required
- Real time visualisation, coherence control
- Drag & drop
- and much more !



READY2CREATE?

Easy and quick creation of your personalized enclosure, wide range of accessories and components.

- Height: 6 to 47U
- Width: 600 mm to 800 mm
- Depth: 300 mm to 1200 mm
- Mounting service for all the mechanical, electrical or electronic components
- Customized versions of IP20 and IP55 enclosures
- EMC solutions
- Accessories, fixing kits
- Machining or special colour on request for VARISTAR range
- 3D pre-visualisation (PDF)
- CAD data downloadable



Electronics cabinets INTERSCALE M - THE FORM FACTOR FOR THE FUTURE

With its innovative design, the Interscale box by SCHROFF is the ideal solution to help you in your projects development, from the prototype to serial production. Additionally to an unbelievable flexibility, Interscale M also offers an EMC protection and eases the changes, for a truly personalized design.



3 service levels are offered for the table enclosures and for the 19" version of the Interscale M by SCHROFF:

- **Standard:** 21 models without holes, 19 with holes, available from the shelf.
- **Modified:** Different personalisation offered: Colours, printings, machining, based on the standard models.
- **Personalized:** On demand realisations, adapted to your project.

Card tray

The ideal solution for electronic systems

Subrack cases and rackmount 19" cases enhanced platform offer flexible solutions for several applications (military, telecom, transport, test & measures...). Many products show remarkable HF performances, and are offered as kit, which can be optimized with dedicated accessories, or modified with customized components.



Network cabinets VARISTAR network cabinets

The more complex and demanding your environment is, the more you expect from your server and network enclosures.

- Server or network enclosure application
- Versatile range (dimensions)
- Components fully compatible
- Continuous development

Varistar is designed to provide outstanding shock and vibration stability, offers shielding against high frequency interference and is built to provide long-term durability you can rely on.

High mechanical stability to Bellcore Zone 4 in accordance with IEC 61587-2. Compliant MIL 901D, Varistar offers outstanding shielding protection: 60dB for 1 GHz, 40 dB for 3 GHz.

With attention to every detail, the proven design, quality materials and craftsmanship ensure that Varistar cabinets will meet your most demanding security tasks in an economically way.



Outdoor enclosures COMLINE Outdoor cabinets for the most challenging operating conditions.

The outdoor cabinets from SCHROFF offer a large range of models and dimensions, to fulfil the most demanding expectations for telecom, transport and network applications, matching your budget.

Designed to protect your electrical equipment against weather conditions, dust and vandalism, SCHROFF aluminium outdoor enclosures are available in single or double wall versions.

Customized versions are also possible, like IP55, EMC shielding, seismic resistance, solutions for thermal management. Thanks to a UV resistant powder paint coating, offering a good corrosion resistance, these high-quality outdoor enclosures are build to last.

SCHROFF also offers a level 3 integration service, so you can get a full equipped enclosure as per your request.



EKOM range

Aluminium enclosures, for outdoor applications - RAL7035

Components in the enclosure are well protected through the high protection degree, but also by anti-vandalism features and high thermal management efficiency. They are the ideal solution for your components housing in outdoor applications. The MULTICOM ranges from ELDON meet the requirements of the high demanding applications, as railways, road traffic management, network and mobile phone applications.

EKOM - SW: Single wall model

Single door: IP66 - 2 or 3 doors: IP55 - IK10

Mounting plate (Zn) and bottom plates to order separately.



Dimensions (mm)			Number of door(s)	Enclosure	Mounting plate (galvanized)	Aluminium plinth H100	Aluminium bottom plate
H	W	D					
1200	600	400	1	ELDEKOM12064-SW	ELDMP1206 + ELDMPA06	ELDPFAL1064	ELDCBPA064
1200	600	600	1	ELDEKOM12066-SW	ELDMP1206 + ELDMPA06	ELDPFAL1066	ELDCBPA066
1200	800	400	1	ELDEKOM12084-SW	ELDMP1208 + ELDMPA06	ELDPFAL1084	ELDCBPA084
1200	800	600	1	ELDEKOM12086-SW	ELDMP1208 + ELDMPA06	ELDPFAL1086	ELDCBPA086
1200	1200	400	2	ELDEKOM12124-SW	ELDMP1212 + ELDMPA06	ELDPFAL1124	2xELDCBPA064
1400	1800	400	3	ELDEKOM14184-SW	3xELDMP1406 + 2xELDMPF1400 + 3xELDMPA06	ELDPFAL1184	3xELDCBPA064



EKOM Double wall model

Single door: IP66 - 2 or 3 doors: IP55 – IK10

Mounting plate (Zn) and bottom plates to order separately.



Dimensions (mm)			Number of doors	Enclosure	Mounting plate (galvanized)	Aluminium plinth H100	Aluminium bottom plate
H	W	D					
1200	600	600	1	ELDEKOM12066	ELDMP1206 + ELDMPA06	ELDPFAL1066	ELDCBPA066
1200	800	600	1	ELDEKOM12086	ELDMP1208 + ELDMPA06	ELDPFAL1086	ELDCBPA086
1400	600	600	1	ELDEKOM14066	ELDMP1406 + ELDMPA06	ELDPFAL1066	ELDCBPA066
1400	800	600	1	ELDEKOM14086	ELDMP1408 + ELDMPA06	ELDPFAL1086	ELDCBPA086
1200	1200	600	2	ELDEKOM12126	ELDMP1212 + ELDMPA06	ELDPFAL1126	2xELDCBPA126
1400	1800	500	3	ELDEKOM14185	3xELDMP1406 + 2xELDMPF1400 + 3xELDMPA06	ELDPFAL1185	3xELDCBPA065



Accessories:

Lifting eyes (4 pieces)		ELDLE9304
Door stop		ELDDSTP02
19 "profiles	24U (H1200)	ELDCIP24
	29U (H1400)	ELDCIP29
19 "profile brackets	W = 600	ELDCIB600
	W = 800	ELDCIB800

ECOM range

ECOM range

Aluminium painted RAL7035 - frame 304L stainless steel - IP66 - IK10

Climatic and Chemically active substances resistance according to EN61969-3 "Mechanical structures for electronic equipment. Outdoor enclosures"

Aluminium, double wall, single door combination enclosure for outdoor use.

High IP66 protection degree, anti-vandalism features, effective thermal management capabilities (aluminium)

Sloped rainhood with integrated rain gutter and ventilation channels around the perimeter.

Double wall door, rear panel, side panels - aluminium painted RAL7035 (100% polyester).

Frame: AISI304L pre-grained stainless steel, one piece bottom plate with extruded polyurethane gasket.

Mounting plate and side panels to be ordered separately.



Dimensions (mm)			Number of door (s)	Enclosure	Side panels	Plinths H100
H	W	D				
1600	600	600	1	ELDECOM16066	ELDSPMA1606	ELDPFAL1066
1600	800	600	1	ELDECOM16086	ELDSPMA1606	ELDPFAL1086
1800	600	600	1	ELDECOM18066	ELDSPMA1806	ELDPFAL1066
1800	800	600	1	ELDECOM18086	ELDSPMA1806	ELDPFAL1086
2000	600	600	1	ELDECOM20066	ELDSPMA2006	ELDPFAL1066
2000	800	600	1	ELDECOM20086	ELDSPMA2006	ELDPFAL1086

ECOM accessories

Aluminium mounting plate

Dimensions (mm)		Reference
H	W	
1600	600	ELDMPAL1606 + ELDMPA06
1600	800	ELDMPAL1608 + ELDMPA06
1800	600	ELDMPAL1806 + ELDMPA06
1800	800	ELDMPAL1808 + ELDMPA06
2000	600	ELDMPAL2006 + ELDMPA06
2000	800	ELDMPAL2008 + ELDMPA06



Aluminium bottom plates

Dimensions (mm)		Reference
W	D	
600	600	ELDCBPA066
800	600	ELDCBPA086



Ground mounted plinths

Dimensions (mm)		Reference
W	D	
600	600	ELDPGM10066
800	600	ELDPGM10086



Filter fans

FF range

IP54 - RAL7035 - side mounting

Easy-to-mount click-in system, new clips for an easier fitting (no need to screw the filter fan for firm fixing). No tool required to remove the cover for an easy access to the filter mat. New frame design for a draining effect, continuous integrated sealing gasket for a flush mounting.

Different colours possible on request: black RAL9005, white RAL9010, RAL7032 dark grey.



FANFFxxU

Description	Reference		Filter IP54	Filter IP55
	Filter fan	Exhaust filter		
12/9 m ³ /h - 230 V - 50/60 Hz - 105 x 105	FANFF08A230UN	FANFF08U	FANM08FPPFK	---
45/32 m ³ /h - 230 V - 50/60 Hz - 150 x 150	FANFF12A230UF	FANFF12U	FANM12FPPFK	FANM12FPPF5K
100/64 m ³ /h - 230 V - 50/60 Hz - 204 x 204	FANFF13PA230UF	FANFF13U	FANM13FPPFK	FANM13FPPF5K
105/90 m ³ /h - 230 V - 50/60 Hz - 250 x 250	FANFF15PA230UF	FANFF15U	FANM15FPPFK	FANM15FPPF5K
230/158 m ³ /h - 230 V - 50/60 Hz - 250 x 250	FANFF15A230UF	FANFF15U	FANM15FPPFK	FANM15FPPF5K
520/430 m ³ /h - 230 V - 50/60 Hz - 325 x 325	FANFF20A230UE	FANFF20U	FANM20FPPFK	FANM20FPPF5K
730/520 m ³ /h - 230 V 50/60 Hz - 325 x 325	FANFF20GA230UE	FANFF20U	FANM20FPPFK	FANM20FPPF5K

Roof exhaust units

RAL7035

Description	Reference	
	Filter fan	Roof exhaust units
423/466 m ³ /h - IP54 - 230 V - 50/60 Hz	FANTP19U230B54	FANFF20U
800/585 m ³ /h - 230 V 50/60 Hz	FANT22U230B	FANFF20U
2100/1920 m ³ /h - 230 V - 50/60 Hz	TEXDLK42BXOB	FANFF20U



FANTP19U230B54

Other models / voltages available.
Please contact us.

Heaters

Natural convection	Reference	Voltage
30W - Cable - metal housing	FANHWM030	110-240 V AC / DC
45W - Terminal - metal housing	FANHTM045	110-240 V AC / DC
60 W - Terminal - metal housing	FANHTM060	110-240 V AC / DC
100 W - Terminal - metal housing	FANHTM100	110-240 V AC / DC
150 W - Terminal - metal housing	FANHTM150	110-240 V AC / DC



FANHTM100

Available in plastic or metal casing. Please contact us.

With integrated fan - metal housing	Reference
250W - 230V AC - no thermostat	FANHVMS250THP230
350W - 230V AC - no thermostat	FANHVMS350THP230



FANHVMS250THP230

Also available with other power, voltage. Please contact us.

Thermostats - Hygrostats

Description	Reference
Thermostat 1 NC (-10 to +80°C)	FANTRT10A230VNC
Thermostat 1 NO (-10 to +80°C)	FANTRT10A230VNO
Thermostat 1 changeover contact	FANTRT230VS01
Thermostat 1NO + 1NF	FANTRT210A230VNCNO
Hygrostat	FANIGR35F



FANTRT10A230VNC and FANTRT10A230VNO



FANTRT210A230VNCNO

Other models and temperature ranges available on request. Please contact us.

Filter fans

New range "FILTER FAN PLUS"

IP54

With the new Air-flap outlet technology, these filter fans are more effective and offer a considerable increase in airflow.

Tool free ratchet mounting system, with integrated blocking system, suitable for walls thickness from 1 to 4 mm.

The new air-flap outlet technology eliminates the need for the filter mat for the air outlet, reducing maintenance operations and enhancing the exit air flow.



STE01871030

Cut-out H x W (mm)	Voltage	FPI system (airflow direction "in")			FPO system (Airflow direction "out")		
		Description	Filter fan	Exhaust filter	Description	Filter fan	Exhaust filter
92 x 92	230 V AC	13/19 m3/h	STE01870030	STE11870000	15/24 m3/h	STE01880000	STE11880030
124 x 124	230 V AC	42/52 m3/h	STE01871030	STE11871000	47/97 m3/h	STE01881000	STE11881030
176 x 176	230 V AC	139/170 m3/h	STE01872030	STE11872000	137/263 m3/h	STE01882000	STE11882030
223 x 223	230 V AC	271/305 m3/h	STE01873030	STE11873000	281/536 m3/h	STE01883000	STE11883030
291 x 291	230 V AC	373/433 m3/h	STE01874030	STE11874000	413/727 m3/h	STE01884000	STE11884030

FPI: Flow "in": Filter fan entry - exhaust grill with flaps
 FPO: Flow "out": Entry grill with filter, exhaust fan with flaps

Heaters

Natural convection - Anti-contact housing

Description	Reference
CS060 - 50 W - Terminal - 120-240 V AC / DC	STE06000000
CS060 - 100 W - Terminal - 120-240 V AC / DC	STE06010000
CS060 - 150 W - Terminal - 120-240 V AC / DC	STE06020000



STE06010000

Compact ventilated heater, plastic housing

Description	Reference
CS028 - 150 W - 230 V AC - No thermostat - Clip fixing	STE02800000
CSL028 - 250 W - 230 V AC - No thermostat - Clip fixing	STE02811000
CSL028 - 400 W - 230 V AC - No thermostat - Clip fixing	STE02810000
CR027 - 400 W - 230 V AC - with thermostat - clip fixing	STE02700000
CR027 - 550 W - 230 V AC - with thermostat - clip fixing	STE02701000



STE02700000

Other models available (Power from 5 to 1000W). Please contact us.

Thermostats - Hygrostats - Hygrotherms

Description	Reference
Thermostat 1 NC (heating) 0 to +60°C	STE01146900
Thermostat 1 NO (fans) 0 to +60°C	STE01147900
Thermostat 1 changeover contact	STE01170000
Double thermostat 1NO + 1 NC	STE01172000
Hygrostat	STE01220000
Hygrotherm (electronic)	STE01230000



STE01146900
+STE01147900



STE01230000

Lighting

Enclosures lights Fluorescent or LED lights. For the series LED025: Connector or cables have to be ordered separately.

Description	Reference
SL025 - Fluo + switch + socket - 230V AC	STE02521000
SL025 - Fluo + switch- no socket- 230V AC	STE02527114
LED025 + switch - screw fixation - 120-240V AC	STE02540001
LED025 + switch + magnet fix - 120-240V AC - 120-240V AC	STE02540000
LED025 + sensor + magnet fix.	STE02541000
LED025 power supply cable 2x1.5mm ² - 2m + female socket AC	STE244356
LED025 daisy chain cable 2x1.5 mm ² - 1m	STE244358
LED025 female connector (entry)	STE264057
LED025 male connector (exit)	STE264058



LED025 range

Cooling units

A thermal management software is available to help you to define your cooling unit. Please get in touch with your local sales technician.

EGO

Cooling units - External side mounting (recessed or semi-recessed possible on request. Please contact us)

Electronic controller - Cooling power from 300W to 15 KW - Units 800W and above: Integrated anti-condensation evaporation system. RAL7035 - Other colours or s/steel housing possible on request.

Cooling cap. (W) EN814 A35/A35	Outside dimension			Voltages (Voltage / number of phases / Freq.)			
	H	W	D	230/1/50-60	115/1/50-60	400-440/2/50-60	400/3/50-60
300	340	525	135	TEXEGOS3BT1B	-	-	-
380	460	285	180	TEXEGO04BT1B	TEXEGO04CT1B	-	-
640	606	316	212	TEXEGO06BT1B	TEXEGO06CT1B	TEXEGO06GT1B	-
820	783	348	215	TEXEGO08BT1B	TEXEGO08CT1B	TEXEGO08GT1B	-
1000	783	348	215	TEXEGO10BT1B	TEXEGO10CT1B	TEXEGO10GT1B	-
1250	999	405	237	TEXEGO12BT1B	TEXEGO12CT1B	TEXEGO12GT1B	-
1600	999	405	237	TEXEGO16BT1B	TEXEGO16CT1B	TEXEGO16GT1B	-
2000	999	405	237	TEXEGO20BT1B	TEXEGO20CT1B	-	TEXEGO20LT1B
2900	1270	500	336	TEXEGO30BT1B	-	-	TEXEGO30LT1B
3850	1270	500	336	TEXEGO40BT1B	-	-	TEXEGO40LT1B



EGO

Also available in outdoor version, or stainless steel housing.

SKY

Side mounting cooling units - Recessed

Electronic controller - Cooling power from 300W to 15 KW RAL7035 - Other colours or s/steel housing possible on request.

Cooling cap. (W) EN814 A35/A35	Outside dimension			Voltages (Voltage / Nb of phases / Frequency)			
	H	W	D	230/1/50-60	115/1/50-60	400-440/2/50-60	400/3/50-60
1050	950	400	233	TEXSKY10BTOB	TEXSKY10CTOB	TEXSKY10GTOB	-
1550	950	400	233	TEXSKY15BTOB	TEXSKY15CTOB	TEXSKY15GTOB	-
2050	1265	400	236	TEXSKY20BTOB	TEXSKY20CTOB	-	TEXSKY20LTOB



SKY

DEK

Roof mounting cooling units

Electronic controller - Cooling power from 300W to 15 KW - Power from 410 to 3850W RAL7035 - Other colours or s/steel housing possible on request.

Cooling cap. (W) EN814 A35/A35	Outside dimension			Voltages (Voltage / Nb of phases / Frequency)			
	H	W	D	230/1/50-60	115/1/50-60	400-440/2/50-60	400/3/50-60
410	264	259	486	TEXDEK04BTOB	TEXDEK04CTOB	-	-
840	340	340	600	TEXDEK08BTOB	TEXDEK08CTOB	TEXDEK08GTOB	-
1150	415	401	567	TEXDEK12BTOB	TEXDEK12CTOB	TEXDEK12GTOB	-
1550	415	401	567	TEXDEK15BTOB	TEXDEK15CTOB	TEXDEK15GTOB	-
2050	415	401	567	TEXDEK20BTOB	TEXDEK20CTOB	-	TEXDEK20LTOB
2900	496	492	797	TEXDEK30BTOB	-	-	TEXDEK30LTOB
3850	496	492	797	TEXDEK40BTOB	-	-	TEXDEK40LTOB



DEK

Air / Air heat exchangers

MIX - Side mounting units

RAL7035 - Other colours or stainless steel housing possible on request.

Cooling Power (W / K)	Outside dimension			Voltages (Voltage / Nb of phases / Frequency)	
	H	W	D	230/1/50-60	115/1/50-60
14	363	188	165	TEXMIX14BXOB	TEXMIX14CXOB
36	771	316	93	TEXMIX36BXOB	TEXMIX36CXOB
80	1260	317	108	TEXMIX80BXOB	TEXMIX80CXOB



MIX

GENERAL ACCESSORIES

Profiles, cable management

DIN profiles

Zn - lg 2m

Description	Dim	Reference
Symmetric - full	7 x 35	TEKDIN1055
	15 x 35	TEKDIN1060
Symmetric - holes	7 x 35	TEKDIN1065
	15 x 35	TEKDIN1070
Asymmetric - full		TEKDIN1075
Asymmetric - with holes		TEKDIN1080

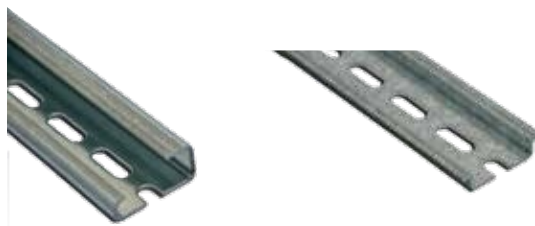

Accessories:

Description	Dim	Reference
45° support	M5	TEKDIN1030
	M6	TEKDIN1035
Clip for symmetric profile	M4	TEKDIN1110
	M5	TEKDIN1115
Clip for asymmetric profile	M3 + M5	TEKDIN1100
	M4 + M6	TEKDIN1105



45° support



Clip rail

C profiles - with holes

Galvanized steel - 3m bars

Size	Reference
10 x 20	ELDCP1020
20 x 20	ELDCP2020
20 x 40	ELDCP2040
35 x 35	PRO04103109005000

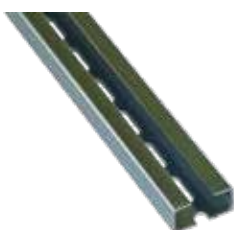

Sliding nuts for CP ELDON profiles (pack of 50 pieces)

For CP profile	M6	M8
20 x 20	ELDGLM20-6P	ELDGLM20-8P
20 x 40	ELDGLM40-6P	ELDGLM40-8P

Cable management

RUTASEAL - Click-in cable glands EPDM - RAL7035 - IP66

Ø	Ø cables	Reference
M16	6 to 9 mm	TST1458304
M20	8 to 13 mm	TST1458305
M25	11 to 17 mm	TST1458306
M32	15 to 20 mm	TST1458307



Also available in PG version, or other colour - Contact us.

KLICKSEAL - Grommet with strain relief RAL7035

Ø	Ø cables	Reference
M20	7 to 11 mm	TST1475803
M25	7 to 13 mm	TST1475804



Multi-entries grommets

See page 11



Multi-entries grommets

Membrane gland plates

See page 11



Membrane gland plates

Cable entry frames

Flexible, to compose according to your need.

Entirely dismantlable, allows the integration of pre-wired devices without having to remove the connector.



Cable gland frame

Side cable entries / exits

Allows pre-wired cable penetration with 90° angle.



Side exit

Dismountable cable gland

Allows pre-wired cable penetration without removing the connector.



Dismountable cable gland

GENERAL ACCESSORIES

Enclosures light, sockets, windows, paint cans

Fluo lights:

Model	Description	Reference
SL025	Ultra-flat light 11W 230V AC +socket + sw -screw fix	STE02521000
SL025	Ultra-flat light 11W 230V AC +socket + sw -magnetic fix	STE02521104
SL025	Ultra-flat light 11W 230V AC +sw- no socket	STE02527000
SL025	Ultra-flat light 11W 230V AC +sensor - no socket	STE02527004
Fluo light 8W 230V + sw + cable 2m		FANCLGT238
Fluo light 12 W 230V + sw + cable 2m		FANCLGT2312
Fluo light 16 W 230V + sw + cable 2m		FANCLGT2316
Magnetic support for CLGT strip		FANCLG-TSM1

Other models available. Please contact us.



LED lights

Description	Reference
LED light 24-48V AC/DC + switch	STE02540101
LED light 24-48V AC/DC + sensor	STE02541101
FLL LED light 230V AC + switch	FANFLL230565US
FLL LED light 230V AC + sensor	FANFLL230565UIR
FLL - Magnetic fixation kit	FANFLL2MA
Eco LED light 4W 230V AC + sw + cable 1.75m	ELDTL4001-4W
Eco LED light 9 W 230V AC + sw + cable 1.75m	ELDTL4001-9W

Other models / voltages available. Please contact us.



Power outlets

Sockets for DIN profile mounting

Description	Reference
250V AC - French socket - with integrated fuse	STE03501000
250V AC - French socket - without fuse	2CSM110000R0711

Also available in different countries formats (Germany, UK, Switzerland, Italy, US ... Please contact us)



Protection windows

Polycarbonate - IP54 - Clear lid

Size	Description	Reference
60 x 77	for 2 modules	FIB3730660
96 x 77	for 4 modules	FIB3730661
130 x 77	for 6 modules	FIB3730662
162 x 77	for 8 modules	FIB3730663
199 x 77	for 10 modules	FIB3730664



Polycarbonate - IP65 / 66 - Clear lid

Size	Description	Reference
248 x 128	for 12 modules	FIB3730775
248 x 218	for 24 modules	FIB3730776
342 x 295	Depth 88 mm	FIB8561824
452 x 400	Depth 88 mm	FIB8561804

Aluminium / safety glass - IP54

Size	Reference
300 x 300	ELDADA03030
400 x 300	ELDADA04030
500 x 400	ELDADA05040
600 x 400	ELDADAB06040
800 x 600	ELDADAB08060
Mounting kit for ADA window	ELDADAMK
Mounting kit for ADAB window	ELDADABMK



ELDADAxxxx



ELDADABxxxx +
ELDADABMK

Also available in different dimensions. Please contact us.

Paint cans & cleaning products

Description	Reference
RAL7035 (spray - 400ml)	CRC31079
RAL7022 (spray - 400ml)	ELDBFP7022
RAL7032 (spray - 400ml)	CRC12017
Touch-up pen RAL7035	ELDBFT7035
Stainless steel cleaning product (bottle 250ml)	ELDSSC01
Stainless steel cleaning product (spray 500ml)	CRC20720



CRC12017



ELDSSC01

TECHNICAL INFORMATIONS

Comparison of materials

Enclosures location and environmental conditions are crucial to select the appropriate material.

Mild steel painted enclosures are suitable for indoor use, in industrial applications.

Stainless steel enclosure are particularly suitable in aggressive environments, or when it's mandatory to comply with strict hygienic prescriptions.

Polyester enclosures are adapted to corrosive atmospheres, indoor or outdoor.

Material selection for the plastic boxes:

The following table gives a general idea of the various material's properties

Exposure to	PC	ABS	Polyester reinforced fibreglass	PA6
Outdoor use	****	*	*****	****
Indoor use	*****	*****	*****	*****
Cost	***	*****	*	**
Weight	*****	*****	***	*****
High rigidity	***	*	****	***
Impact resistance	*****	***	****	***
alt water environments	*****	**	*****	*****
Neutral salt	*****		*****	****
Acids, low concentrate	*****	****	*****	****
Acids, high concentrate	***	*	***	*
Alkalis, low concentrate	***	*****	****	**
Alkalis, high concentrate	*	****	****	*
Petroleum	***	*	*****	****
Hydraulic oil	*****	*****	*****	*****
Alcohols	*****	***	****	****
Solvents	*	*	*****	
Cooling fluids	***	*****	*****	

***** = Excellent * = Poor

Stainless steel type and finish selection:

AISI304 stainless steel: The most commonly used stainless steel type in Food and Beverage industry, for its corrosion resistance and cleanability.

- Corrosion prevention, especially if exposed to organic acids.
- Resistance to nitrous gases and condensation water combined action, and in most of the aggressive environments.

AISI316L stainless steel: Also called "marine stainless steel". Suitable for high salinity or chlorinated environments due to its high corrosion resistance thanks to the addition of Molybdenum in its chemical composition.

- Better corrosion resistance.
- Specifically suitable for the applications where the atmosphere contains acids, chlorine, bromine and saline halides or when very corrosive additives or solvents are used.

The surface finish is also an important data to take in consideration to ensure a good cleanability.

A smoother surface means less bacterial contamination risks, less adhesion of material and a really nice finish.

ELDON enclosures are made of 400 pre-grained stainless steel, polished to Ra<0.8µ.



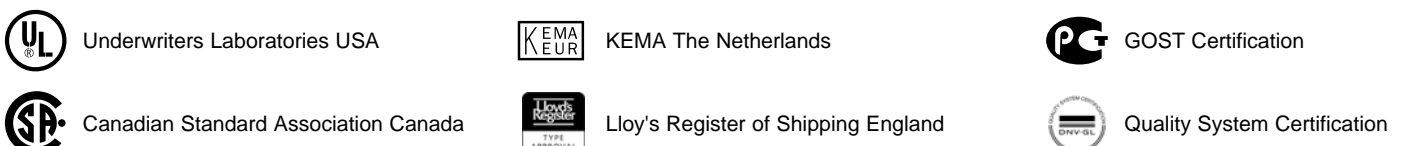













Certificates & international standards, and the corresponding logos:



TECHNICAL INFORMATIONS









IP rates

In Europe, the degree of protection is indicated by the IP rate (International Protection Rating), it includes 2 numbers (acc IEC 60529)

IP rate: 1st number Degree of protection with respect to persons and solid objects			IP rate: 2nd number Degree of protection with respect to harmful ingress of water		
0	Non protected		0	Non protected	
1	Protected against solid objects greater than Ø 50mm 50mm		1	Protected against dripping water	
2	Protected against solid objects greater than Ø 50mm 12 mm		2	Protected against dripping water of +/- 15° angle	
3	Protected against solid objects greater than Ø 50mm 2.5 mm		3	Protected against dripping water of +/- 60° angle	
4	Protected against solid objects greater than Ø 50mm 1 mm		4	Protected against water splashing	
5	Dust protected		5	Protected against water jet	
6	Dust-tight		6	Protected against heavy seas	
			7	Protected against immersion	
			8	Protected against submersion	
			9	Protected against high pressure & temperature jets	

Additionally to the IP rate, there's another index that evaluates the impact resistance: IK (IEC 62262).



IK code Protection against mechanical outside impacts		
IK00	Non protected	
IK01	Protected against an impact energy of 0.15 J	
IK03	Protected against an impact energy of 0.35 J	
IK05	Protected against an impact energy of 0.7 J	
IK06	Protected against an impact energy of 1 J	
IK07	Protected against an impact energy of 2 J	
IK08	Protected against an impact energy of 5 J	
IK09	Protected against an impact energy of 10 J	
IK10	Protected against an impact energy of 20J	

NEMA: National Electrical Manufacturers Association. It's a US manufacturers organization which actively promotes standardized product specifications for electrical apparatus.

Main NEMA classifications and approximative IP equivalents.

NEMA Type 1	IP30	Indoor use primarily to provide a degree of protection against limited amounts of falling dirt.
NEMA Type 4	IP66	Indoor or outdoor use primarily to provide a degree of protection against windblown dust and rain, splashing water, hose-directed water and damage from external ice formation.
NEMA Type 4X	IP66	Indoor or outdoor use primarily to provide a degree of protection against corrosion, windblown dust and rain, splashing water, hose-directed water and damage from external ice formation.
NEMA Type 12	IP55	Indoor use primarily to provide a degree of protection against circulating dust, falling dirt and dripping non-corrosive liquids.
NEMA Type 13	IP65	Indoor use primarily to provide a degree of protection against dust and spraying of water, oil and non-corrosive coolants.



The technical Solution

www.etngroup.com

DISTRIBUTOR

- ◇ **Automation**
- ◇ **Electrotechnical equipment**
- ◇ **Process Instrumentation**
- ◇ **Industrial Ethernet**
- ◇ **Variable speed drive system**
- ◇ **Vision & Industrial Ethernet**
- ◇ **Robotics**
- ◇ **EMC**

Your agency

